

CX-TR Transformer Series

INSTALLATION INSTRUCTIONS

THIS PACKAGE INCLUDES:

- (1) Transformer
- (1) Parts kits

1. GENERAL DESCRIPTION

Camden offers a range of 12VAC to 24VAC standard, plug-in and panel (nipple) mount transformers to support any low voltage system application.

2. SPECIFICATIONS

Voltage	120V AC 60HZ
Dimensions	<p>CX-TRN-2024: 2"H x 2-3/8" W x 2-1/4"D (50mm X 59mm x 56mm)</p> <p>CX-TRX-2012: 2"H x 2-3/8" W x 2-1/4"D (50mm x 59mm x 56mm)</p> <p>CX-TRX-2024 2-1/8"H x 2-3/8"W x 2"D (54mm x 59mm x 50mm)</p> <p>CX-TRX-4024 2"H x 2-3/8" W x 2-1/4"D (50mm x 59mm x 64mm)</p> <p>CX-TRP-4016 3-3/4"H x 2-5/8" W x 2-1/4"D (94mm x 67mm x 57mm)</p>

3. WIRING INSTRUCTIONS:

1. Determine the size and type of transformer needed, from the chart above.
2. Connect the fuse holder to one of the leads of the transformer secondary insert fuse. (For CX-TRX-2024 only).
3. Connect the secondary leads to the load (i.e. - motion detector, control panel or another device).
4. Once all the secondary wiring is complete, connect the primary leads to the 115 VAC, 60 Hz. 5. Ensure transformer is securely fastened.

4. PRECAUTIONS:

1. Primary power must always be fused or protected by a circuit breaker.
2. Never palace the transformer next to combustibile materials.
3. DO NOT short secondary leads together or allow them to short to ground.

CX-TR TRANSFORMER SERIES

INSTALLATION INSTRUCTIONS

5. TRANSFORMERS FRONT, BACK AND SIDE VIEW

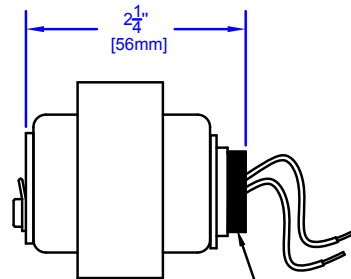
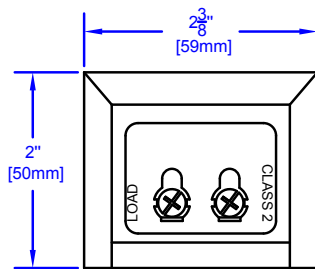
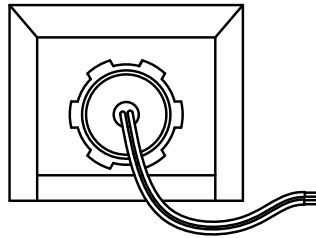

CX-TRN - 2024 - 24V AC 20VA NIPPLE MOUNT TRANSFORMER

Standard 3/4" NPT

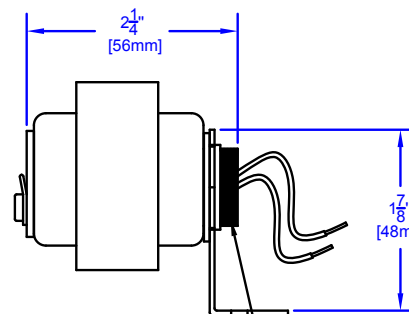
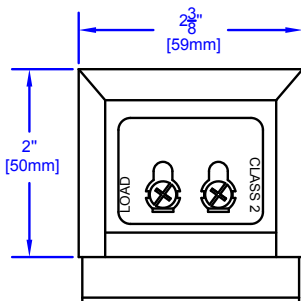
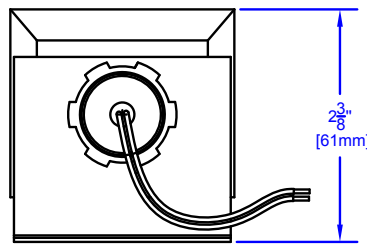
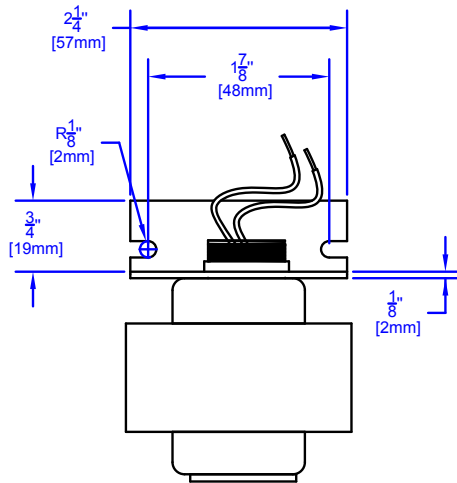

Standard 3/4" NPT

CX-TRX - 2012 12VAC 20VA NIPPLE MOUNT TRANSFORMER.

CX-TR TRANSFORMER SERIES
 INSTALLATION INSTRUCTIONS

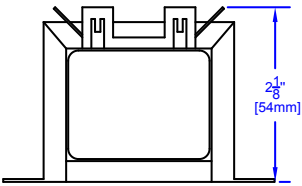
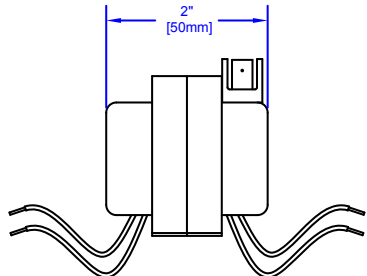
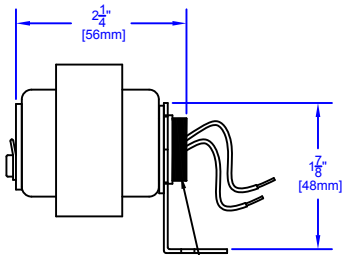
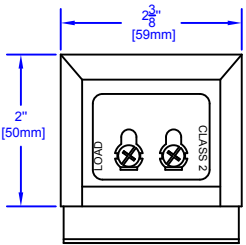
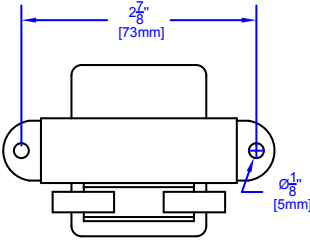
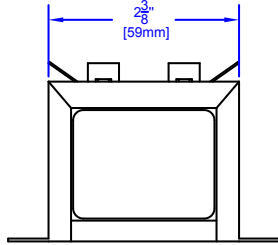
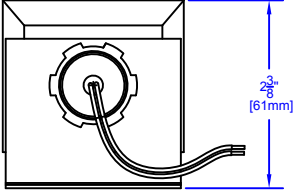
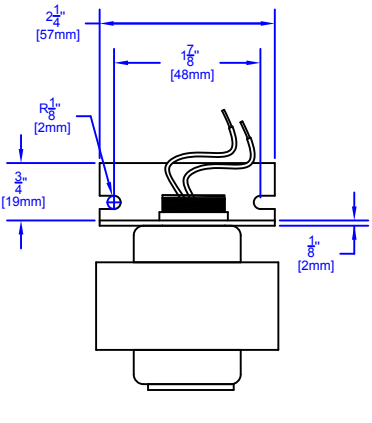

CX-TRX-2012 12VAC 20VA NIPPLE MOUNT TRANSFORMER.

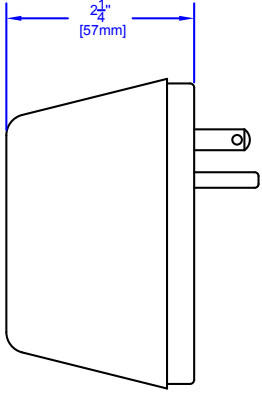
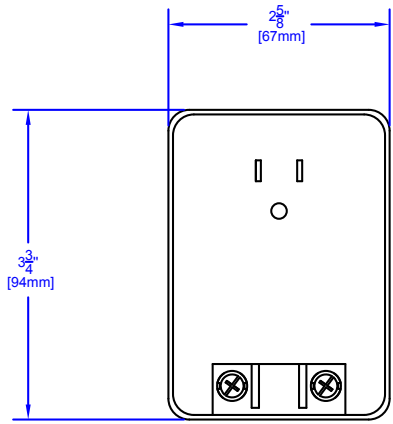

CX-TRX-2024 - 24VAC, 40 VA STANDARD MOUNT TRANSFORMER



CX-TRP-4016 - 16VAC, 40 VA Plug-in transformer

CX-TR TRANSFORMER SERIES

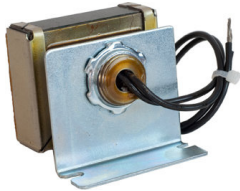
INSTALLATION INSTRUCTIONS

PART NUMBERS		DESCRIPTION
PANEL (NIPPLE) MOUNT		
	CX-TRN-2024	24 VAC, 20VA NIPPLE MOUNT TRANSFORMER
STANDARD MOUNT		
	CX-TRX-2012	12VAC, 20VA STANDARD MOUNT TRANSFORMER
	CX-TRX-4024	24 VAC, 40 VA STANDARD MOUNT TRANSFORMER
FUSED, STANDARD MOUNT		
	CX-TRX-2024	24 VAC, 20 V, FUSED, STANDARD MOUNT TRANSFORMER
PLUG-IN		
	CX-TRP-4016	16 VAC, 40 VA PLUG-IN TRANSFORMER

PARTS KIT

ITEM NUMBER	PART NUMBER	DESCRIPTION
1.	FOR CX-TRN-2024, CX-TRX-2012 & CX-TRX-4024	
	60-34B003	(A) INSULATED RED FEMALE (B) ORANGE PLASTIC WIRE NUT WITH SPRING
	FOR CX-TRX-2024	GLASS FUSE 1.5-AMP 250V FAST BLOW 6.3 X 32MM LONG
	60-34B004	INSULATED RED FEMALE ORANGE PLASTIC WIRE NUT WITH SPRIN