

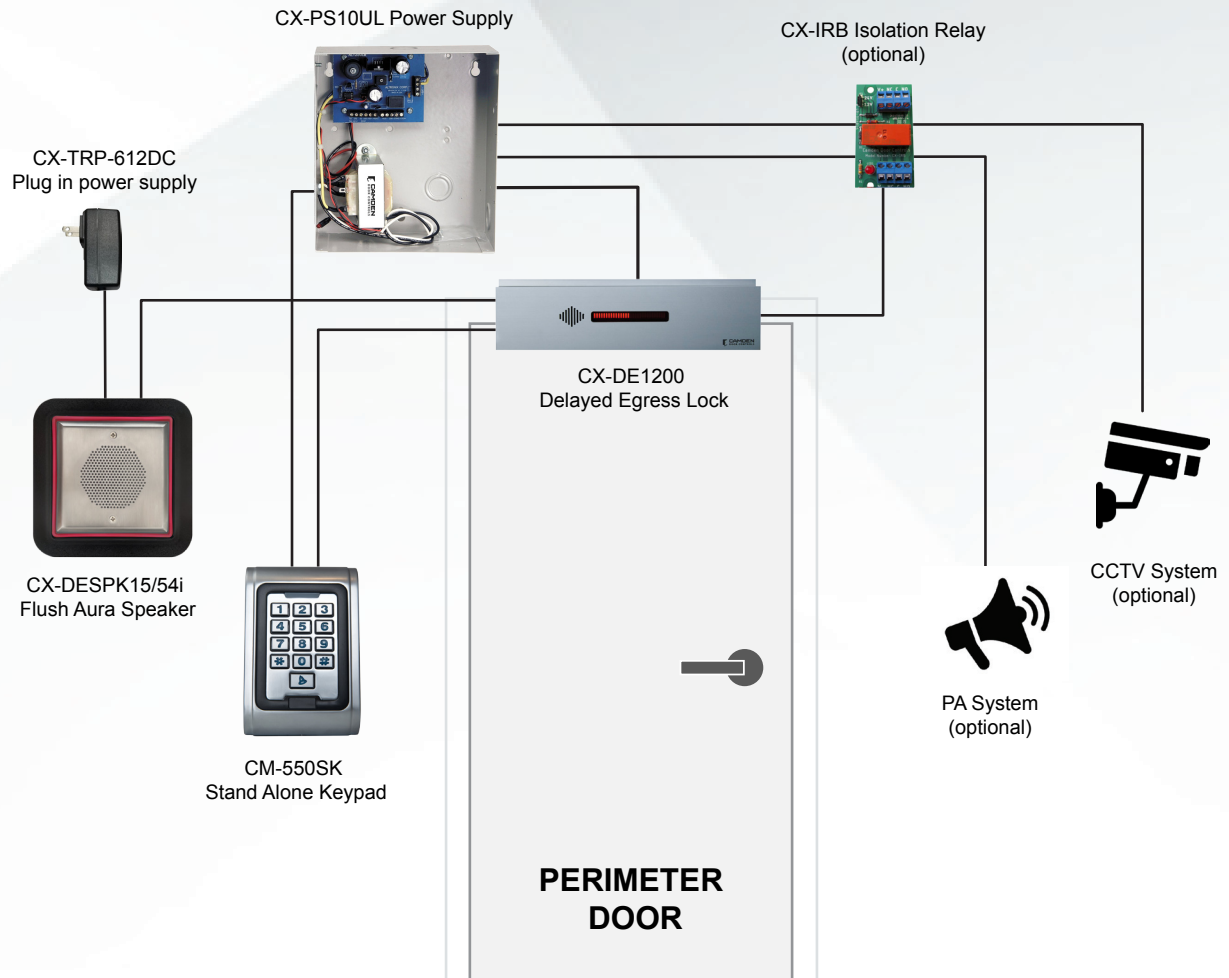

ACCESS CONTROL (SECURITY)

One Door Control w/Alarm



Delayed Egress EM Lock – Wired (Assisted Living Facility)

Single egress door in assisted living facility allows staff to exit with the use of a keypad. Assisted living healthcare patients will be restricted unless the Fire alarm activates or they push the door and start the 15-30 second count-down. Once timer is activated, a local door alarm would be activated.

Note: External doors to have an auxiliary lock (Exit Device/Crash Bar) with no external handle or lever.

FEATURES

- A complete solution including access control system, delayed egress maglock and alarm
- Delayed egress maglock features voice count-down and large LED indicator
- Reset switch to silence alarm
- 3-year warranty

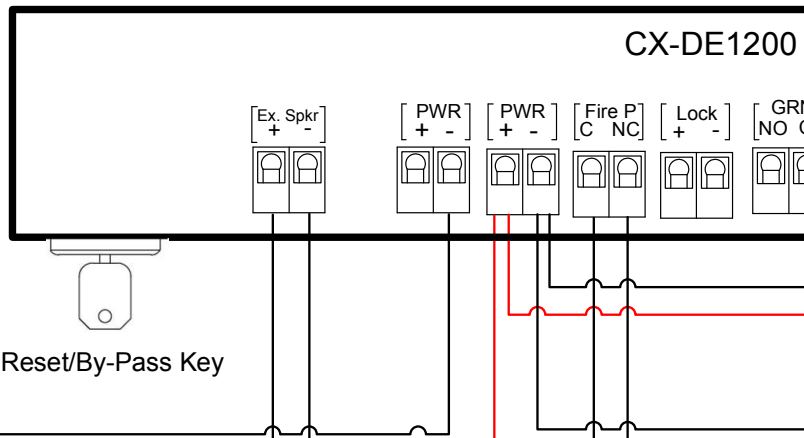
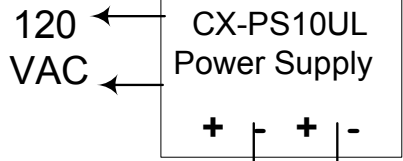

Reset/By-Pass Key

Fire Alarm



Alarm Output Common (GND)

Normally Closed J10 jumper removed

Flush Aura Speaker

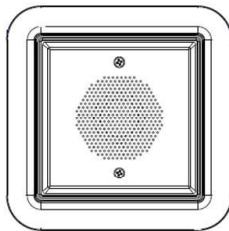

INL

GND

PWR

AC/DC

-PBTN

+

CX-TRP-612DC Plug in Power Supply 12 VDC

120 VAC

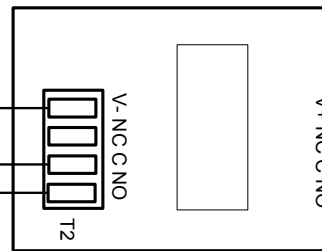

CX-IRB Isolation Field (Optional Exterior Annunciation)

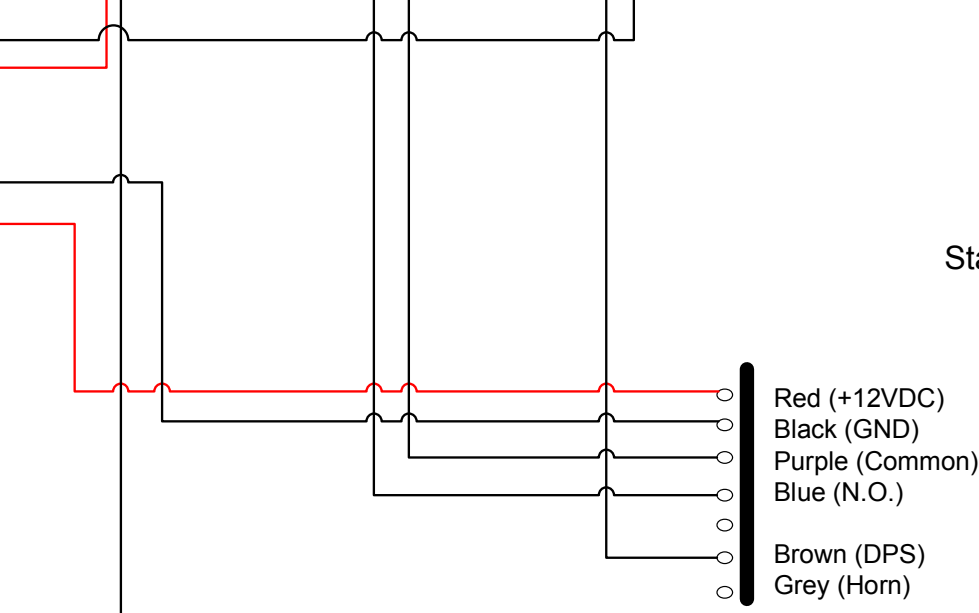
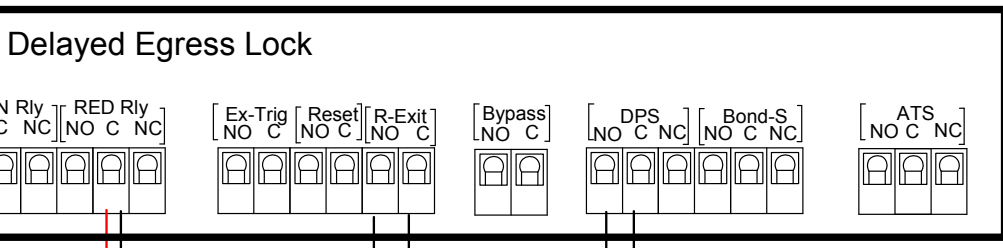

CV-550SPK
Stand Alone Keypad

(Inside)

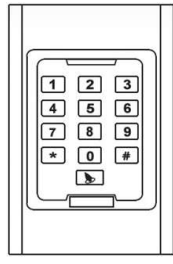

CCTV System



PA System

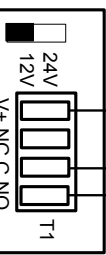

Relay
System Interface)

SPECIFICATIONS	
SYSTEM TYPE: ACCESS CONTROL (SECURITY)	
APPLICATION: DELAYED EGRESS EM LOCK - WIRED	
PROJECT SCOPE: ASSISTED LIVING FACILITY	
DRAWN BY: DAVID ITO	FILE NUMBER: 2.1.4.1.A1



**Remote
Door
Release**



ACCESS CONTROL (SECURITY)

One Door Control w/Alarm



CX-DE1200-N1

Delayed Egress Maglock

- 1200lb holding force
- Nuisance delay, 1-2 seconds
- 12/24 VDC with auto voltage sensing



CM-550SK

Keypads

- Up to 2,000 users
- Back-lit vandal resistant keypad
- All metal, weather resistant IP rated



CX-DESPK15/55i

15-Watt Audio Speaker

- Flush speaker and enclosure
- Super bright LED alarm illumination
- Heavy duty stainless steel grill

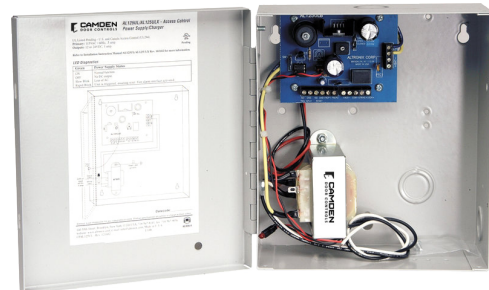

CX-PS10UL

1 Amp Power Supply

- Metal cabinet



CX-TRP

Additional Items

- CX-TRP-612DC – Plug in power supply
- CX-IRB – Isolation Relay (optional)

System Design Approval Required By Local Authority Having Jurisdiction.

This system design information has been provided as a guide only. In all cases, system installation must comply with local codes and standards and be approved by the local AHJ (authority having jurisdictions). Camden Door Controls assumes no liability for errors or omissions contained in this document.